

[01] x 2



[02] x 4



[03] x 2



[04] x 4



[05] x 4



[06] x 1



[07] x 1



[08] x 1



[09] x 1



[10] x 1

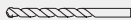
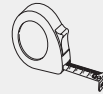
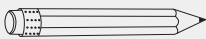
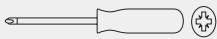
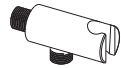

6mm

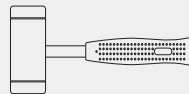
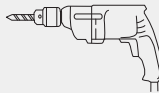

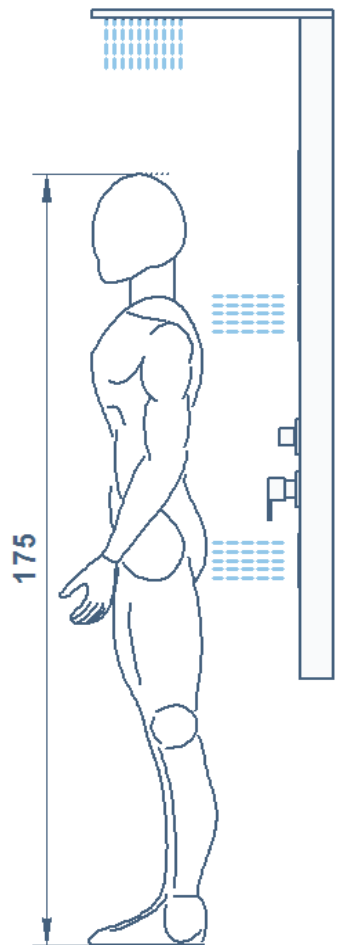
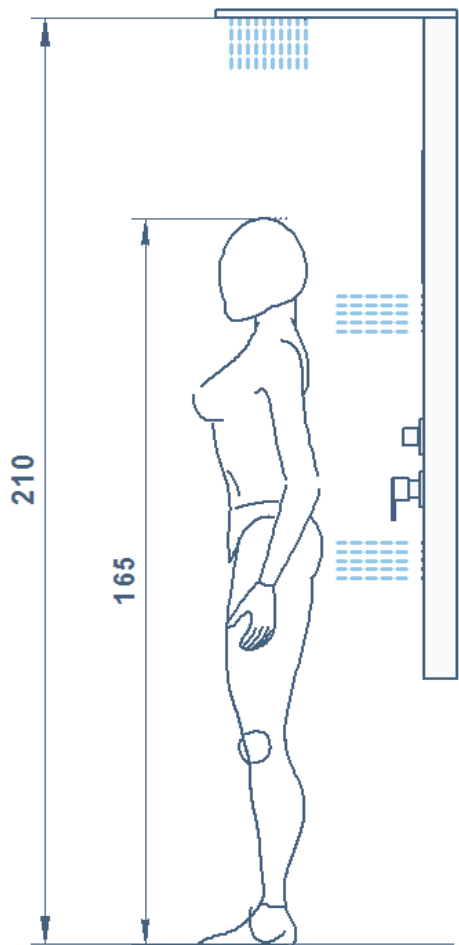

1



[02]



[06]



[07]

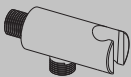

[10]

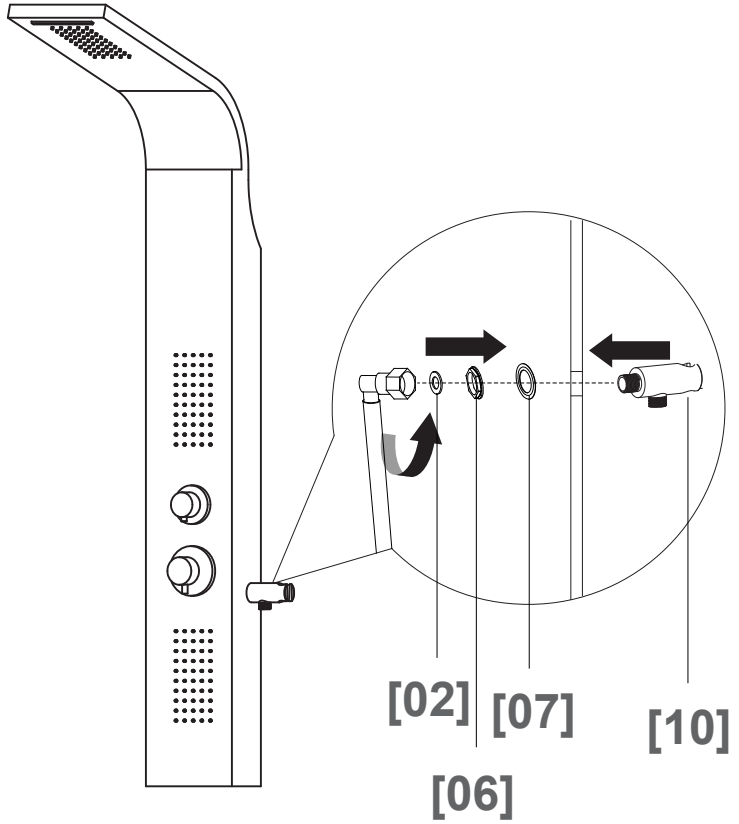

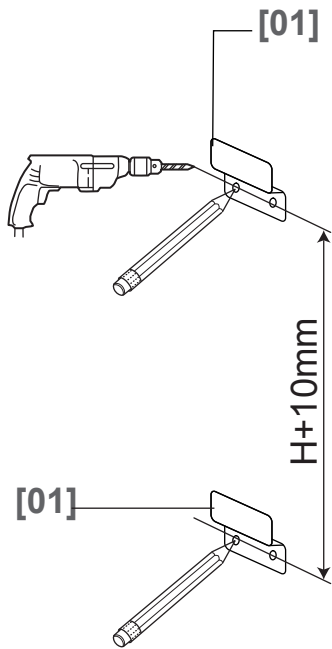
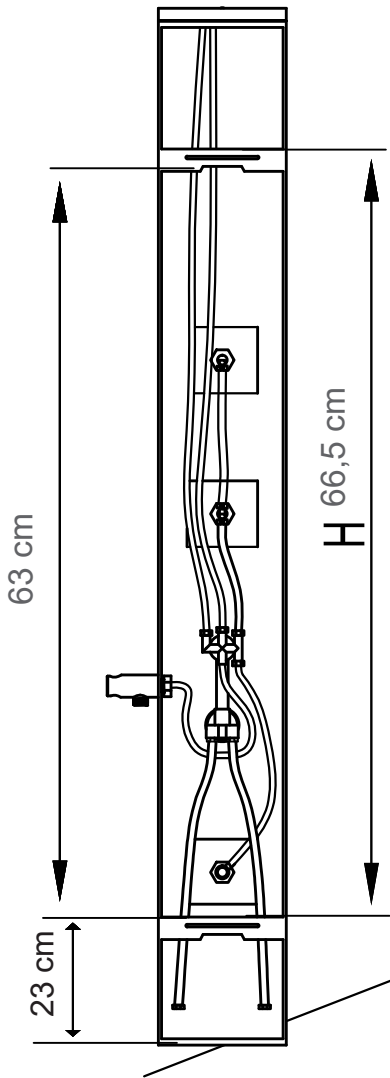

2

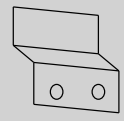

[01]

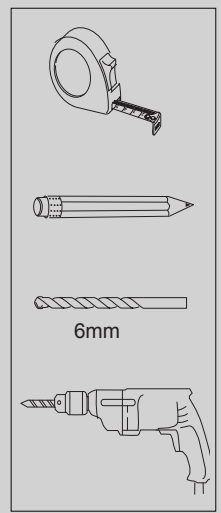

6mm

3

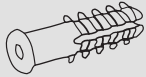

[04]



[05]

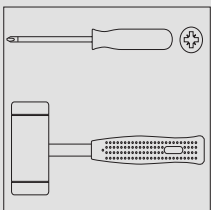

[04]

[05]

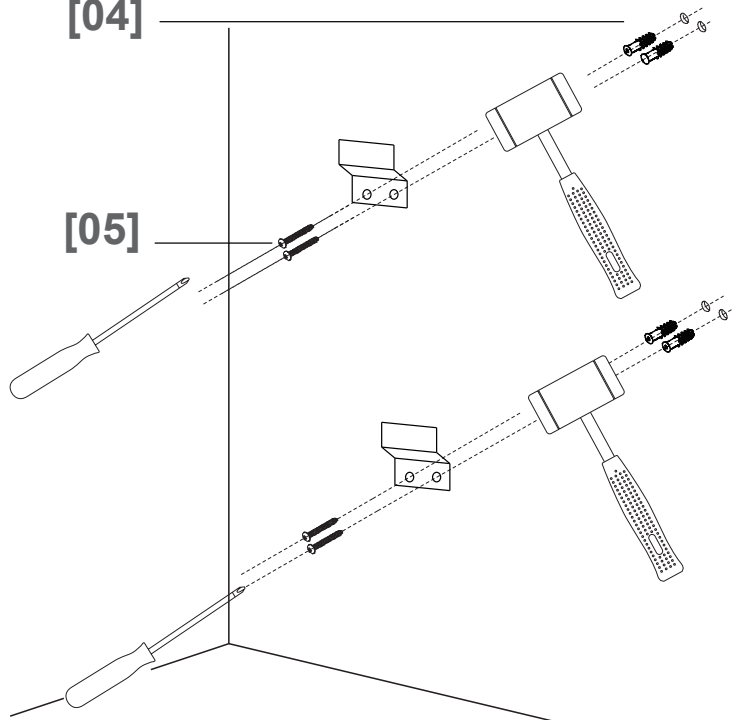

4



[03]

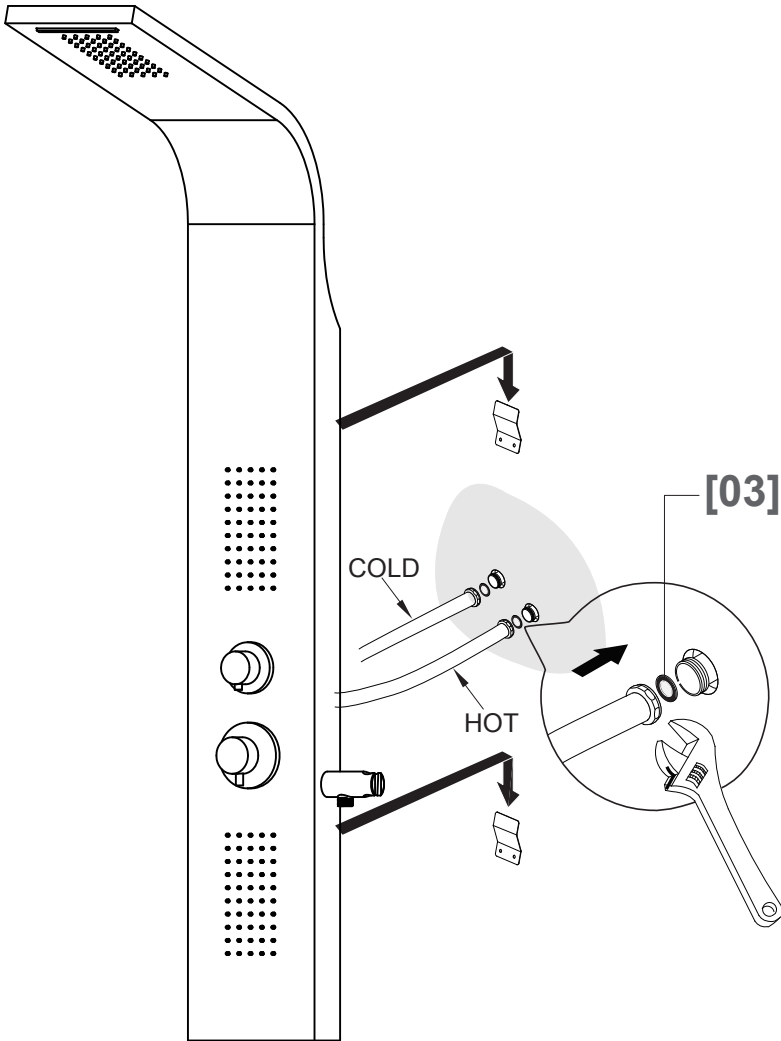

[03]

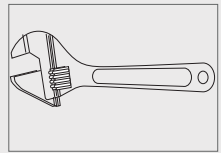

5



[02]



[08]



[09]

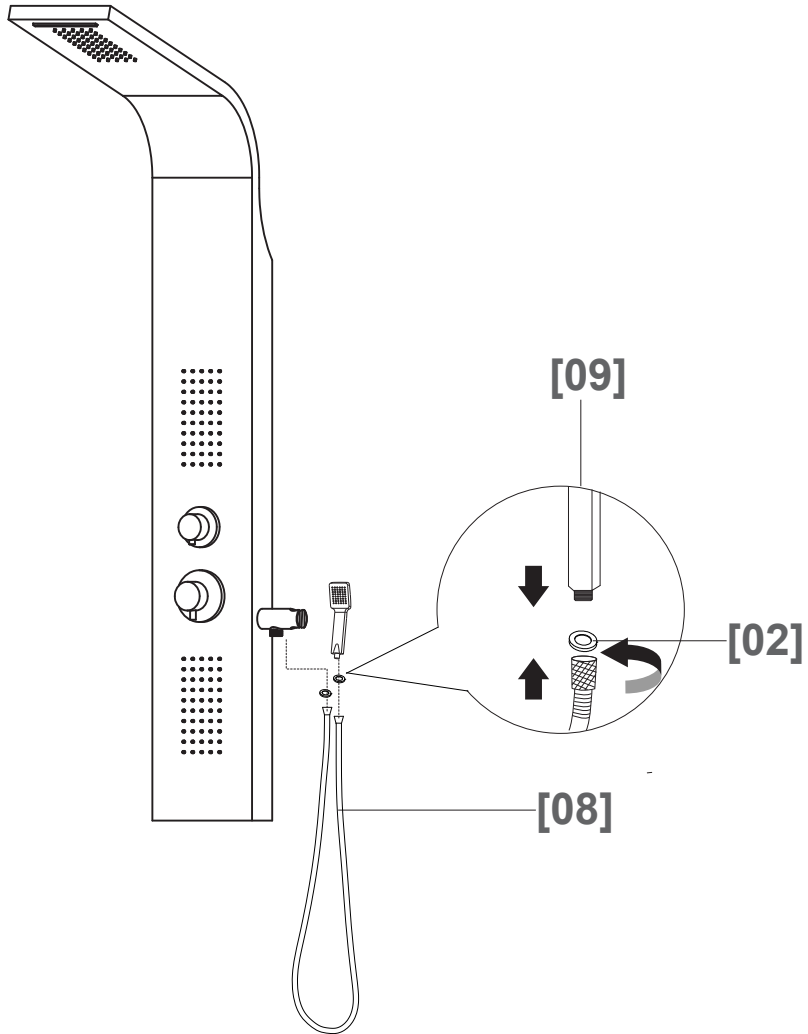

Diverter cartridge installation

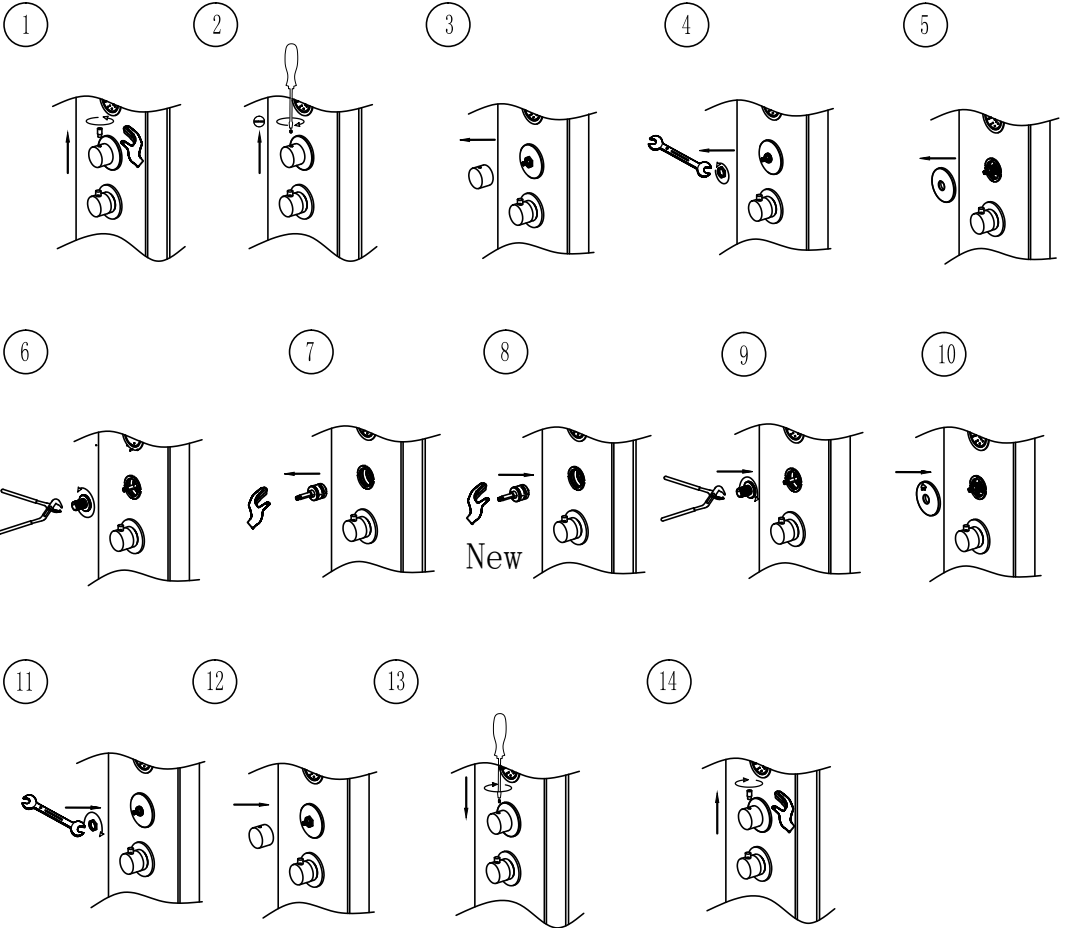

Front-open mixer installation

1

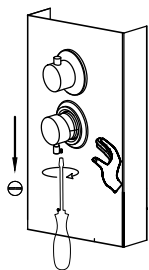

2

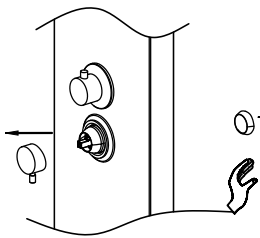

3

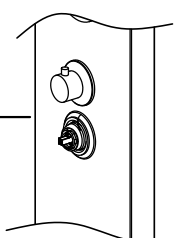

4

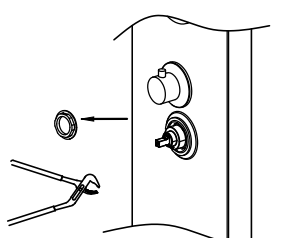

5

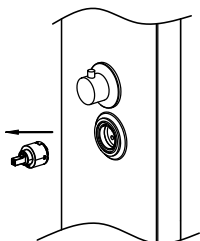

6

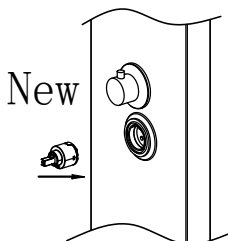

7

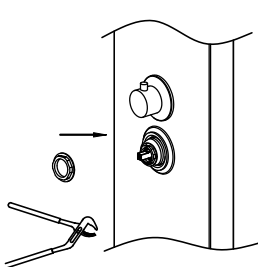

8

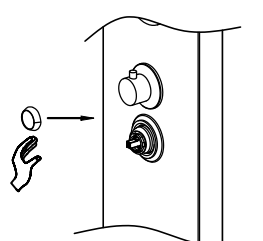

9

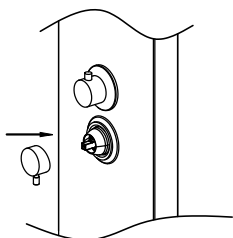

10

